

**Pressure
Relief Valve
(4 x 6
300 lb.)**

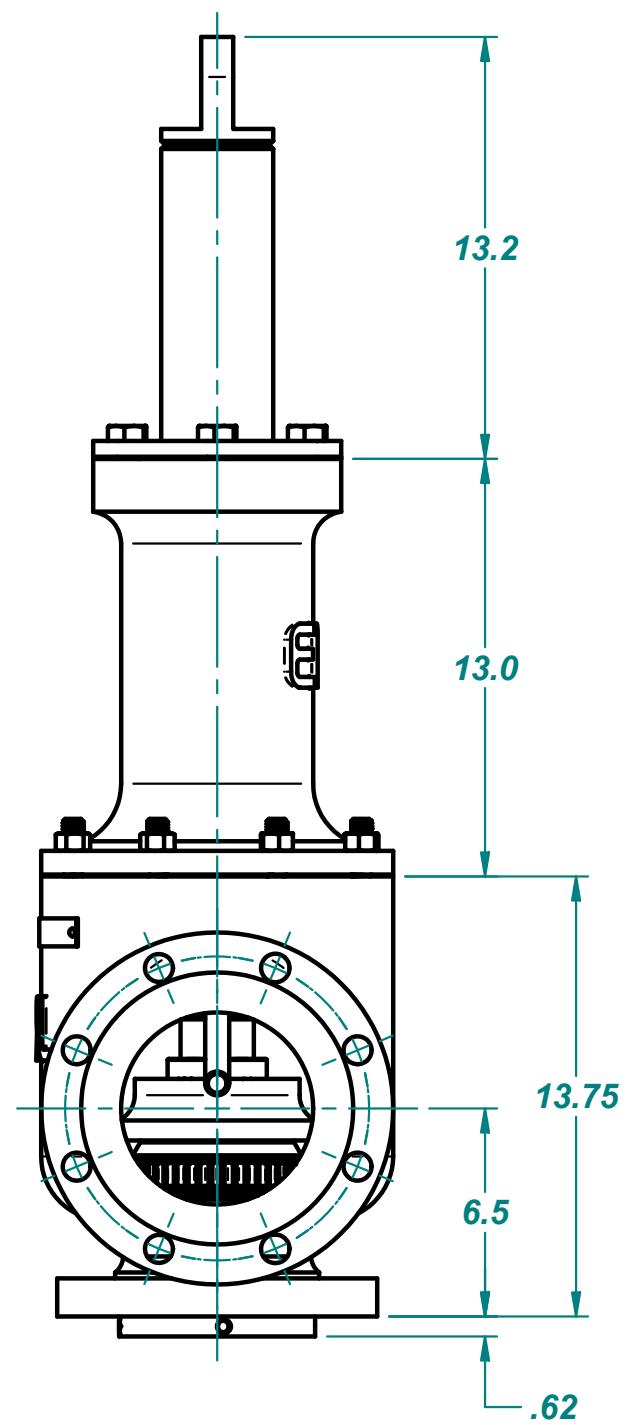
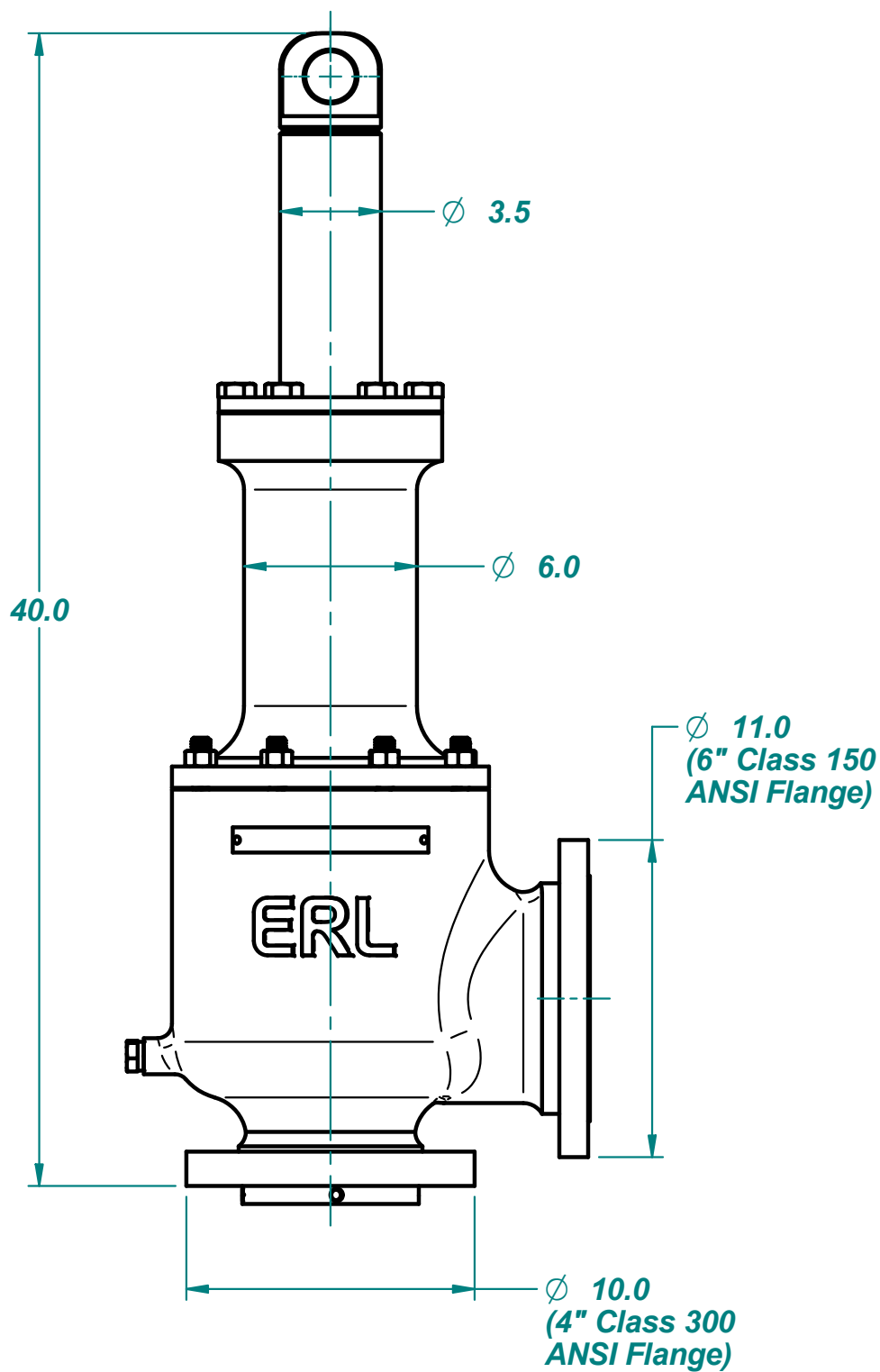

**ELECTROMECHANICAL
RESEARCH LABORATORIES, Inc.**
P.O. BOX 1026
NEW ALBANY, IN 47151

DATE	5/15/20	DRAWN	D. URBAN	PART NAME	Overall Dimensions
		APPROVED		UNIT NAME	Pressure Relief Valve (4 x 6 - 300 lb.)
		SCALE	JOB NO.	DRAWING NO.	ITEM NO.
		nts	n/a	089AF101C-2	PRV-4X6-300
		TOLERANCE			
		0.0 = +/- 0.030			
		0.00 = +/- 0.015			
		0.000 = +/- 0.005			